

NANOCAM+[®]

NCP-DVRW2S

Your Safety. Our Priority



USER MANUAL

Full HD Front & Rear Dash Camera
with 3.0 IPS Screen + WIFI



CONTENTS

1.0	WELCOME TO NANOCAM	7
2.0	BEFORE USE - CAUTION	7
2.1	INFORMATION ABOUT THE BATTERY.....	8
2.2	NOTES ON INSTALLATION	8
3.0	PACKAGE CONTENTS	9
4.0	PRODUCT OVERVIEW	10
5.0	GETTING STARTED	11
5.1	SETTING UP THE MICRO SD CARD IN YOUR DASH CAMERA	11
5.2	INSTALLING YOUR DASH CAMERA.....	12
5.3	ADJUSTING THE CAMERA POSITION	12
5.4	INSTALLING THE REAR CAMERA	13
5.4.1	REAR CAMERA WIRING DIAGRAM.....	14
5.4.2	REAR CAMERA.....	14
5.5	CONNECTING TO POWER.....	15
6.0	POWERING THE DASH CAMERA ON / OFF	15

6.1	AUTO POWER ON/OFF.....	15
6.2	MANUAL POWER ON.....	15
6.3	POWER OFF.....	15
7.0	RESET THE DASH CAMERA.....	16
8.0	PLAYING BACK VIDEO ON A COMPUTER OR LAPTOP (PC).....	16
9.0	INFORMATION ON YOUR DASH CAMERA SETTINGS.....	16
9.1	THE MODE BUTTON:.....	17
10.0	TAKING STILL PHOTOS.....	17
11.0	LOCKED RECORDING.....	18
12.0	SCREEN INTERFACE.....	19
13.0	FUNCTION: VIDEO MODE.....	20
13.1	VIDEO RESOLUTION:.....	20
13.2	LOOP RECORDING.....	21
13.3	MICROPHONE.....	21
13.4	LANE DEPARTURE WARNING SYSTEM (LDWS).....	22

14.0	FUNCTION: PHOTO MODE	22
14.1	RESOLUTION	23
14.2	PHOTO QUALITY.....	23
14.3	EXPOSURE	24
14.4	ISO SENSITIVITY	24
14.5	CONTRAST	24
14.6	SHARPNESS	25
14.7	SATURATION	25
14.8	LEVELS	26
15.0	FUNCTION: PLAYBACK MODE	26
15.1	VOLUME	27
15.2	DELETE	27
15.3	LOCKING AND UNLOCKING PHOTO AND VIDEO FILES.....	28
16.0	FUNCTION: GENERAL SETTINGS	29
16.1	KEYPAD TONE.....	29
16.2	SET THE TIME	30
16.3	TIME FORMAT	30

16.4	DATE FORMAT	31
16.5	GPS STAMP	31
16.6	LANGUAGE	31
16.7	FLICKER.....	32
16.8	SCREEN SAVER	32
16.9	G-SENSOR	33
16.10	MOTION DETECTION	33
16.11	FACTORY RESET	34
16.12	FORMATTING THE INSERTED MICRO SD CARD	34
16.13	FIRMWARE VERSION (FW VERSION)	35
16.14	CONNECTING WIFI	35
17.0	APP FUNCTIONS.....	37
17.1	VIDEO PLAY BACK	37
17.2	VIDEO DOWNLOAD	38
17.3	SHARING A FILE ON SOCIAL MEDIA	39
18.0	WARRANTY TERMS & CONDITIONS.....	40

1.0 WELCOME TO NANOCAM

Thank you for purchasing a NanoCam Dash Camera. Our product has been designed to be a valuable addition to your vehicle, certain to make your driving experience safer and more enjoyable. Our products, like most after-market safety Dash Cameras, are innovations intended to be used to compliment the driver experience but not to replace the actual, physical, manual function of the person driving the vehicle.

Please read through these instructions before attempting to install this product. Please regularly check our website for the latest manual and product updates at www.nanocamplus.com.au or www.nanocamplus.co.nz

2.0 BEFORE USE - CAUTION

- Always use your Dash Camera within your countries' current road laws.
- Dash Cameras with radio frequencies and unventilated spaces with direct sunlight can damage the unit.
- It is normal for the Dash Camera to get warm during use.
- It is important to set the time and date before you use this Dash Camera.
- Dash Camera notifications are suggestions only, please drive to the actual conditions.
- This Dash Camera is for non-commercial use.

2.1 INFORMATION ABOUT THE BATTERY

- The Dash Camera will only work in your vehicle when connected via the provided 12/24V adaptor. This Dash Camera is fitted with a Super capacitor, which is similar to a battery but functions differently. It has not been designed to be used as the camera's built-in battery.
- Incorrect charging can damage the internal battery and will consequentially void the warranty.
- Never dismantle, expose, or manually replace the internal battery.
- Do not dispose of the Dash Camera in fire.
- Dispose of the Dash Camera observing local regulations and with the environment in mind.

2.2 NOTES ON INSTALLATION

To get the best results from your Dash Camera, please be aware:

- The Dash Camera should be installed near the rear-view mirror, top centre of the windshield.
- Ensure the lens is within range of the windscreen wiper so it is not obstructed by rain.
- Fingerprints on the lens can result in unclear videos or photos and should be cleaned with a microfibre cloth.
- Do not install the Dash Camera on a tinted window. It can damage the tint film and reduce the quality of the Dash Camera's recordings.
- Clean the windscreen thoroughly before affixing the mount to maintain the adhesive.
- To position the Dash Camera accurately, we suggest you power-on the Dash Camera and test the playback image on screen first, prior to removing the mount's 3M tape. This way you can

easily relocate the unit until you have found the optimal spot.

3.0 PACKAGE CONTENTS



Dash Camera



Rear Camera



12/24V Adapter



3M Mount



User Guide



7M Rear Camera Cable

4.0 PRODUCT OVERVIEW

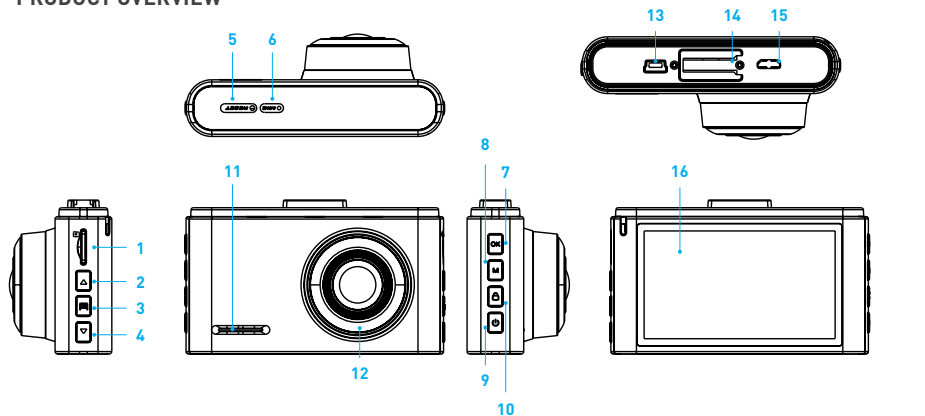

1. Micro SD card slot*
2. Up Button (▲)
3. Menu Button (☰)
4. Down Button (▼)
5. Reset
6. Microphone

7. Rec/OK Button
8. Mode Button
9. Lock Recording Button (🔒)
10. ON/OFF Power Button (🔌)
11. Speaker
12. Lens

13. Mini USB power socket
14. Slot for fixing 3M Mount
15. Rear Camera connector slot
16. Display Screen

*Note: Micro SD card is not included and must be purchased separately.

5.0 GETTING STARTED

Before you start, the Dash Camera will need a Micro SD card installed.

The Dash Camera will also need to be installed into your vehicle and connected to your power source to operate.

5.1 SETTING UP THE MICRO SD CARD IN YOUR DASH CAMERA

A Micro SD card will be required, class 10 or higher (you will need to purchase separately)

- The Micro SD card will need to be formatted before use (see instructions on page 34).
- Insert the Micro SD card only when the Dash Camera is powered OFF.
- To insert the Micro SD card properly:
 - Turn off the Dash Camera and point the screen towards you.
 - Insert the Micro SD card into the slot on the left-hand side of the Dash Camera. Push the Micro SD card in until a slight click is heard, and it feels secure.
 - In order to remove the Micro SD card:
 - Turn off the Dash Camera and push the Micro SD card in, until a click is heard.
 - This indicates the Micro SD card has been released and can be pulled out with your fingers.

5.2 INSTALLING YOUR DASH CAMERA

- Clean the inside of your windscreen and select a place to mount your Dash Camera.
- Remove the protective stickers from the Dash Camera and the 3M mount.
- Press the mount base firmly against the windscreen and hold for 30 seconds.
- Insert the power cable adaptor into the Dash Camera power socket.

NOTE:

- It is recommended that the Dash Camera is installed behind your vehicle's rear-view mirror.
- Please ensure the camera view is not obstructed by any window tint or any other objects.

5.3 ADJUSTING THE CAMERA POSITION

- Loosen the knob and adjust the Dash Camera vertically and/or horizontally.
- Tighten the knob to make sure the Dash Camera is securely locked in place.

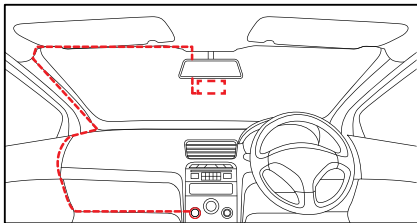

5.4 INSTALLING THE REAR CAMERA

- Clean the inside of your rear window and select a place to mount your rear camera.
- Remove the protective film from the rear camera base bracket.
- Select either the top or the bottom of the rear window to position the rear camera and press down on the base of the bracket by hand for 30 seconds to ensure that the sticker adhesive has attached to the car window.

Connect the rear camera to the Dash Camera using the cable provided. Either run the cable through the roof lining or under the carpet underlay as shown on page 14. The rear camera can rotate 360° degrees depending on the position and type of installation method required.

Method 1: Thread the rear camera cable along the top of the roof lining and connect it to the Dash Camera.

Method 2: Lift up the car carpet and run the rear camera cable along the underlay of the carpet and connect it to the Dash Camera. Adjust the camera by rotating the barrel until it captures the entire road.

5.4.1 REAR CAMERA WIRING DIAGRAM

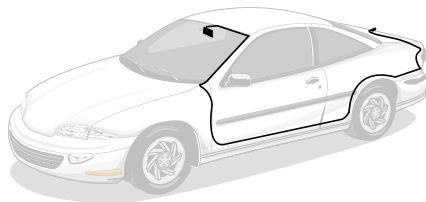
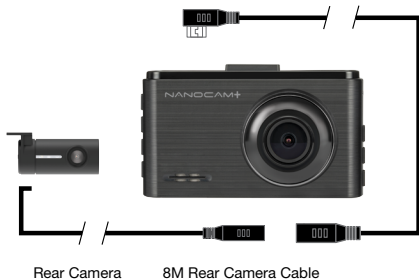

5.4.2 REAR CAMERA

Both Dash Cameras will instantaneously start recording after the Dash Camera is powered ON.

Both Front and Rear Camera images will now be displayed on your Dash Camera's 3.0" Screen, and you can switch between each screen using the UP key.

The Camera Display can switch between cameras and show the following:

- Full front camera view
- Full rear camera view
- Half front and half rear view
- Full front with small window for rear view
- Full rear with small window for front view

5.5 CONNECTING TO POWER

Only use the included 12/24V Power Adaptor to power the Dash Camera.

- Once the Dash Camera is securely installed on your vehicle's windscreen, plug the 12/24V power adaptor into your vehicle's cigarette lighter.
- Run the cable along your vehicle's console and windscreen and plug the USB Micro plug into the Dash Camera. (See image on page 12).

6.0 POWERING THE DASH CAMERA ON / OFF

6.1 AUTO POWER ON/OFF

When the Dash Camera is correctly installed and connected to your vehicle's 12/24V power supply, the Dash Camera will automatically power up and start recording when the vehicle accessories are activated.

6.2 MANUAL POWER ON

Hold the  Power Button on the side of the Dash Camera until the NanoCam Plus start-up screen appears.

6.3 POWER OFF

Ensure the Dash Camera has stopped recording and press the  Power Button. Wait 10 seconds before turning it back on.

7.0 RESET THE DASH CAMERA

Restarting the Dash Camera can help when the unit isn't functioning as it should. To restart the Dash Camera, with a flattened paper clip press the small button on its underside.

8.0 PLAYING BACK VIDEO ON A COMPUTER OR LAPTOP (PC)

To playback video files on your PC, remove the Micro SD from the Dash Camera and connect it directly to your PC using a USB Micro SD card reader, a built-in card reading slot or a Micro SD/SD card converter (also not included).

Once the Micro SD card is connected, a folder named 'removable storage Dash Camera,' should appear. By transferring and saving files onto your computer, often playback of your recordings is quicker and smoother.

9.0 INFORMATION ON YOUR DASH CAMERA SETTINGS

Before using the Dash Camera, it is critical that you insert and format your Micro SD card and set the Time and Date via the Dash Camera's settings (instructions to do this are on page 29/30).

FUNCTION, MODE AND USAGE NOTES:

- Menu options can not be used while the camera is recording, so please cancel recording first.
- The Time and Date will be stamped onto your footage using the Date Stamp setting.
- When the Dash Camera is connected (via the supplied adaptor) to your vehicle's 12/24V power supply, it will automatically power on and begin recording.

- At first, the Dash Camera functions will be unresponsive and will take a moment to start recording. Please note, when your vehicle is off, the Dash Camera will also stop recording.
- Because of how some vehicles are wired, recording may continue when the engine is off. You can remove the power adaptor or manually turn off the Dash Camera to avoid this.

9.1 THE MODE BUTTON:

The Mode Button is on the right-hand side of the Dash Camera and is marked with an "M".

- The Mode Button is used to switch the Dash Camera function from Video to Camera mode, which can take still photos.

10.0 TAKING STILL PHOTOS

To take still Photos with the Dash Camera, you will need to stop recording and adjust the mode settings by following these steps:

- Press the **OK** Button to press 'stop the Dash Camera recording'.
- Press the Mode Button located on the RIGHT side of the Dash Camera to enable the photo function.
- To take a photo, press the **OK** Button.
- To revert to Video recording mode, press the Mode Button again.

NOTE: The Dash Camera must be connected to power to take still photos.

11.0 LOCKED RECORDING

Locked Recording saves the current video file and protects it from being overwritten. To manually create a Locked Recording follow the instructions below.

- During recording push the  Button.

NOTE:

- If the G Sensor function is enabled and a collision is detected, the Dash Camera will automatically trigger the Emergency Recording and lock the current video file. Please refer to the section titled G Sensor to learn more.
- An Emergency Recording file is created as a new file, which will be locked to avoid being overwritten by normal Loop Recording. If the inserted Micro SD card becomes full with Emergency Recording files, the message “SD Card Full” will appear on the screen and the oldest emergency file will be automatically deleted to make room for a new recording.
- If your Micro SD card becomes full of Emergency Recordings that you wish to keep, please save them to your PC for future reference.

12.0 SCREEN INTERFACE



1. Video Mode
2. Loop Recording
3. Exposure
4. Microphone / Mute Recording
5. Recording Indicator
6. GPS
7. WIFI
8. Recording Time
9. Resolution
10. Park Mode
11. G Sensor
12. Micro SD Card
13. Charging
14. Date
15. Time

13.0 FUNCTION: VIDEO MODE

The four function keys control the drop down MENU options from the top of the LCD screen. In Video Mode, users can select:

Video Recording | Loop Resolution | Microphone | Lane Departure Warning System (LDWS).

- These options allow users to manage video recording, microphone, lane departure and loop recording functionalities.
- To access this section, refer to the top panel function keys.
- Video Mode is the first icon.
- Use the **MENU** Button on the LEFT side of the camera to toggle through function keys and press **OK** when Video Mode is highlighted.
- Now the drop-down MENU box can be activated.

Press **DOWN** to choose either:

Video Recording | Loop Resolution | Microphone | Lane Departure Warning System (LDWS)

- When your preference is highlighted BLUE press **OK**.
- This will open this particular settings options.

13.1 VIDEO RESOLUTION:

Resolution settings impact the quality of a video recording. A higher resolution will capture more detail in a recording, but will result in a larger file.

To customise Video Resolution, please follow the instructions on the next page:

- Select Video Resolution by pressing **OK** when highlighted.
- Press Up or Down to choose either: **FHD 30fps** or **HD 30fps**.
- Select **OK** to confirm.
- When complete, press **MENU** to go back to the main menu.

13.2 LOOP RECORDING

The Loop Recording function allows you to set the duration of time that the Dash Camera will record ongoing footage, before creating a new clip.

To set the clip time of recorded footage, please follow the instructions below:

- Select Loop Recording by pressing **OK** when highlighted.
- Select either 1, 2, 3 4 or 5 minute Loop Recording duration options.
- Press Up or Down to highlight your selection and select **OK** to confirm.
- When complete, press **MENU** to go back to the main menu.

13.3 MICROPHONE

The Dash Camera can either record footage with audio, or without. You can choose your preference by following the instructions below:

- Select Microphone by pressing **OK** when highlighted.
- The options 'On' or 'Off' will present on the next screen.
- Press Up or Down to highlight your selection and select **OK** to confirm.
- When complete, press **MENU** to go back to the main menu.

13.4 LANE DEPARTURE WARNING SYSTEM (LDWS)

The built-in Lane Departure Warning System (LDWS) will constantly monitor the conditions of your driving lane and the road ahead. For your safety, an audible and visual alert will be communicated if, and when your vehicle starts to drift out of its lane.

To activate the LDWS setting, follow these steps:

- Select LDWS by pressing **OK** when highlighted.
- The option On/ Off will present on the next screen.
- Press Up or Down to highlight your selection and select **OK** to confirm.
- When complete press **MENU** to go back to main menu.

14.0 FUNCTION: PHOTO MODE

In the Photo Mode  section, users can select and adjust:

Resolution | Photo Quality | Exposure | ISO Sensitivity | Contrast | Sharpness | Saturation | Levels.

Photo Mode contains options that allow users to manage contrast, sharpness and saturation levels of their photos.

To access this section, refer to the top panel function keys. Photo Mode is the second icon.

Use the **MENU** Button on the LEFT side of the camera to toggle through function keys and press **OK** when Photo Mode is highlighted.

- Now the drop-down menu box can be activated.
- Press **DOWN** to choose either:

Contrast | Sharpness | Saturation | Levels

When your preference is highlighted BLUE press **OK**.

14.1 RESOLUTION

Resolution sets the still image photo quality. Higher resolution images will capture more detail and will also produce larger files.

To adjust the image Resolution, please follow the instructions below:

- Select the Resolution, option, by pressing the **OK** button when highlighted.
- Use the Up and Down buttons to increase or decrease the Resolution level of the image or recording you desire.
- When complete press **MENU** to go back to the main menu.

14.2 PHOTO QUALITY

This setting will adjust the quality of an image. Higher quality images will capture more detail but will also produce larger files. To change the photo quality, please follow the instructions below. Select Photo Quality by pressing the **OK** button when highlighted.

- Use the ▲ Up and ▼ Down buttons to highlight your required quality, then press the OK (Rec/Ok) Button to confirm your selection.

14.3 EXPOSURE

The Exposure Setting allows users to control the light settings. To do this, please, follow the instructions below:

- Select the Exposure option, by pressing the **OK** button when highlighted.
- Use the Up and Down buttons to increase or decrease the Exposure level of the image or recording.
- When complete, press **MENU** to go back to the main menu.

14.4 ISO SENSITIVITY

The ISO Sensitivity setting is used to manage how much light is let into the image sensor. More light will result in blurred movements. A lower ISO level will capture less movement and less light. To change the ISO settings follow the instructions below:

- Select the ISO option, by pressing the **OK** button when highlighted.
- Use the ▲ Up and ▼ Down buttons to increase or decrease the ISO Exposure level of the image or recording.
- When complete, press **MENU** to go back to the main menu.

14.5 CONTRAST

The Contrast setting is used to set the contrast level of the colour in captured images.

Please follow these instructions to adjust this setting.

- Select Contrast by pressing the **OK** button when highlighted.
- Use the ▲ Up and ▼ Down buttons to increase or decrease the Contrast levels.
- When complete, press **MENU** to go back to the main menu.

14.6 SHARPNESS

The Sharpness Setting sets the parameters around the boldness of an image. Sharper images will create bolder images with stronger outlines.

Please follow these instructions to adjust this setting:

- Select the Sharpness option, by pressing the **OK** button when highlighted.
- Use the ▲ Up and ▼ Down buttons to increase or decrease the Sharpness level.
- Press **OK** to confirm.
- When complete, press **MENU** to go back to the main menu.

14.7 SATURATION

The Saturation Setting is used to manually adjust the intensity level of the colours reproduced in captured images. Please follow these steps to adjust to the level of Saturation you require.

- Select Saturation by pressing the **OK** button when highlighted.
- Use the ▲ Up and ▼ Down buttons to increase or decrease the Saturation of the image/ footage.
- When complete, press **MENU** to go back to the main menu.

14.8 LEVELS

The Levels setting is used to manually adjust the level used to counteract different light conditions. This setting is set to Auto by default. To change the Level setting, follow the instructions below:

- Select Levels by pressing the **OK** button when it is highlighted.
- Use the ▲ Up and ▼ Down button to increase or decrease its light balance.
- When complete, press MENU to go back to the main menu.

15.0 FUNCTION: PLAYBACK MODE

In Playback Mode, users can:

Adjust volume | Delete files | Lock and protect video and image files | View recorded footage or still images.

- These functions allow users to manage their video and image files and adjust the volume of the Dash Camera.
- To access this section, refer to the top panel function keys. Playback Mode is the third icon.
- Use the MENU Button on the LEFT side of the camera to toggle through function keys and press **OK** when the Playback Mode  is highlighted.

Press **DOWN** to choose either:

Volume | Delete | Protect | File Folder

- When your preference is highlighted BLUE press **OK**.

- This will open the Settings menu options.

15.1 VOLUME

- Select Volume by pressing **OK** when highlighted.
- To increase or decrease the volume, use the ▲ Up or ▼ Down button that is located on the side of the Dash Camera.

15.2 DELETE

- Select Delete by pressing **OK** when highlighted.
- Two options will present: Delete One (file) or Delete ALL.
- Highlight to either option to select, and press OK.
- Select **Delete ALL** to clear all video and image files, with one press.
- To confirm this selection, press **OK** when **Delete ALL** is highlighted.
- To Delete One file, press **ok** when this option is selected.
- You will see a screen containing thumbnails of your recorded videos or still images.
- You can use the Up and Down arrow button to select which video/ image that needs to be deleted. A selected file will have a red box around it. To delete this file, press **OK**.
- When complete, press the **MENU** button to return to main options.

15.3 LOCKING AND UNLOCKING PHOTO AND VIDEO FILES

This feature allows you to choose which file/s to keep safe and ensure they are not recorded over or overwritten by the Loop Recording feature.

- Select **PROTECT** by pressing OK when highlighted.

It will open a screen with four options:

Protect One | Unprotect One | Protect All | Unprotect All

- Select which option applies and then select the images or videos you want to protect, or unprotect by selecting OK when the file is highlighted by a red bounding box.
- Select **FILE FOLDER** by pressing OK when highlighted.

It will open a screen with three options:

Normal | Parking | Emergency

- This is referring to the context of when the video was recorded either during normal driving, while parking, or when locked in an emergency.
- Use the ▲ Up or ▼ Down bottom to select Normal, Parking or Emergency and press **OK** to select the highlighted option that applies.

16.0 FUNCTION: GENERAL SETTINGS

This section contains options that allow users to customise their Dash Camera experience.

To access, press the **MENU** button to scroll across the top panel function keys. General Settings is the fourth icon.

Use the MENU Button on the LEFT side of the camera to toggle through function keys and press **OK** when the General Settings icon is highlighted.

Now the drop-down MENU box can be activated.

Press **DOWN** to choose either: **Language | Flicker | Auto LCD OFF | G- Sensor | Park Mode | Motion Detection | Factory Reset | Wifi Mode | Format SD Card.**

When your preference is highlighted BLUE press **OK**.

This will open this settings' 9 menu options.

16.1 KEYPAD TONE

You can adjust the keypad tone and mute it. Please follow these instructions:

- Select Keypad Tone by pressing **OK** when highlighted.
- A screen showing the Key Pad Tone options will appear.
- Highlight to select either **ON** or **OFF** with the up or down arrow buttons, and press **OK** to confirm.
- When complete, press the **MENU** button to return to the main options.

16.2 SET THE TIME

Setting the Time of your Dash Camera will help it be admissable in insurance claims.

To set the Time, please follow these steps:

- Select the Time Setting option by pressing **OK** when highlighted.
- A screen showing the Time Setting controls will appear. Use the Up and Down buttons to edit the selected digit. Use the Rec/OK Button to confirm and progress to the next digit, until the time is complete (e.g 12.30pm or 16.40pm).
- To choose a Time Format (e.g 24 Hour or 12 Hour) please see the below section of this manual.
- Press **OK** to confirm the time and date entry. You will be sent back to the sub-menu when the process is complete.

16.3 TIME FORMAT

The Time Format setting allows you to choose what format you want the time to appear. Please follow the steps to adjust:

- Select the Time Format setting option by pressing **OK** when highlighted.
- A screen listing the Time Format options will present with either 12 Hour or 24 Hour time to choose from. Use the Up or Down arrow to make your selection. Once highlighted, press OK to confirm your selection.
- Press **OK** to confirm the Time Format and you will be sent back to the sub-menu when the process is complete.

16.4 DATE FORMAT

The Date Format setting allows you to choose how you want your date to appear.

- Select the Date Format function by highlighting it in the drop down menu and pressing the **OK** button.
- A screen listing the Date Format options will present. Use the Up or Down arrow to make your selection. Once highlighted, press **OK** to confirm your selection.
- When complete, press the **MENU** button to return to the main options.

16.5 GPS STAMP

The GPS Stamp feature will, by default, record GPS co-ordinates onto the video. To turn ON or OFF this feature, follow these steps:

- Select GPS Stamp from the list.
- A screen listing the GPS's Stamp's options of ON or OFF.
- Use the down or up arrow to make your selection. Once highlighted, press **OK** to confirm.
- When complete, press the **MENU** button to return to main options.

16.6 LANGUAGE

- Select Language by pressing **OK** when highlighted.
- A screen listing each language option will drop down. Use the Up or Down arrow to select your language.
- Press **OK** to confirm.

16.7 FLICKER

To reduce the flickering effect from LED lights, the Flicker option will adjust the Dash Camera's recording frequency. To customise this feature, please follow these steps:

- Select Flicker by pressing **OK** when highlighted.
- A screen listing the Flicker Options will present. Use the Up or Down arrow to choose either 50 Hz or 60 HZ. Press **OK** to confirm.
- When complete, press the **MENU** button to return to the main options.

16.8 SCREEN SAVER

Program the Screen Saver to adjust when your Dash Camera screen will automatically switch off. Please note, the Dash Camera will continue recording.

- Select Screen Saver by pressing **OK** when highlighted.
- A screen listing the Screen Saver Options will present. Use the Up or Down arrow to choose your selection of either OFF, 1 or 3 mins, and press **OK** to confirm.
- When complete, press the **MENU** button to return to the main options.

16.9 G-SENSOR

The G Sensor defines the required force needed to trigger an Emergency Recording. Once triggered, the current recording will be saved and protected from being saved over by normal Loop Recording.

To set the required sensitivity please follow the instructions below:

- Highlight the G-Sensor option and press **OK** to open this setting.
- A screen listing the G-Sensor options will present. Use the Up or Down arrow to choose either OFF, High, Middle or Low.
- Highlight to select your preference and press **OK** to confirm.
- When complete, press the **Menu** button to return to the main options.

16.10 MOTION DETECTION

Motion Detection monitors on screen movement and will start recording when movement is detected. Motion Detection will also stop recording after 10 seconds of no on screen movement.

To carry out this task please follow these steps:

- Highlight to select the Motion Detection function and press **OK** to confirm.
- A screen listing the Motion Detection options of ON or OFF will present. Use the Up or Down arrow to choose. Highlight to select your preference and press **OK** to confirm.
- When complete, press the **Menu** button to return to the main options.

16.11 FACTORY RESET

Follow these instructions to restore factory settings, also known as Factory Reset:

- Highlight to select the Factory Reset function and press **OK** to confirm.
- A screen listing options of ON or OFF will present. To restore to original factory settings press **ON**.
- Use the Up or Down arrow to choose. Highlight to select your preference and press **OK** to confirm.
- When complete, press the **Menu** button to return to the main options.

16.12 FORMATTING THE INSERTED MICRO SD CARD

Formatting the Micro SD card will delete all information on the inserted Micro SD card and prepare the card for use with the Dash Camera.

To carry out this operation, please follow these instructions:

- Enter the General Settings Menu.
- Use the Up and Down Buttons to navigate the Settings Menu and highlight the Format Micro SD card option.
- Press Ok to access the Format Micro SD card settings.
- You will be asked if you want to Format the Micro SD card.
- Highlight the **YES** option and press **OK**.
- Press **Menu** to return to the main section.

16.13 FIRMWARE VERSION (FW VERSION)

Firmware Version will show the current firmware version of your Dash Camera.

To check this information, please follow these steps:

- Highlight to select the Firmware Version (FW Version) and press OK to confirm.
- A screen listing the FW Version information will appear. If you are required to update the firmware the option to update will also appear.
- When complete, hit the Menu button to return to main options.

16.14 CONNECTING WIFI

Activating WiFi on your Dash Camera allows you to pair it with your smartphone and use the NCP-Konnect App to review footage and control settings.

To Switch On/Off WiFi please follow these steps:

- Highlight to select the WiFi Mode and press **OK** to confirm.
- A screen listing the WiFi Mode options of ON or OFF will appear.
- Use the Up or Down arrow to choose.
- Highlight to select your preference and press **OK** to confirm.
- When complete, press the **Menu** button to return to the main options.



Please see the following section to see instructions as to how to set up the NCP-Konnect App.

NCP-Konnect App:

- Please download the NCP-Konnect App from the Google play store or Apple Store to your smartphone.
- After successfully downloading and installing the App on your smartphone, search for the NCP-DVRW2S_XXXX (XXXX is unique a number for each Dash Camera) WIFI connection on your smartphone and connect to your Dash Camera by entering password "12345678".
- Please open the App on your smartphone and sync it with your Dash Camera which will display both videos and App settings.



NCP-Konnect App

Scan the QR code to download the NCP-Konnect App.

NOTE:

- To ensure that the DVR pairs with your smartphone properly, please turn on the DVR and keep the smartphone in close proximity to the DVR for successful pairing via Wi-Fi.
- The DVR will need to be continuously powered on to maintain the connection with your smartphone.

17.0 APP FUNCTIONS

17.1 VIDEO PLAY BACK

1. Ensure the NCP-Konnect App is installed on your smartphone and WiFi is connected to your Dash Camera.
2. Open the NCP-Konnect App.
3. Press the Camera Browser icon.
4. Select a Video to playback, once selected it will start playing.

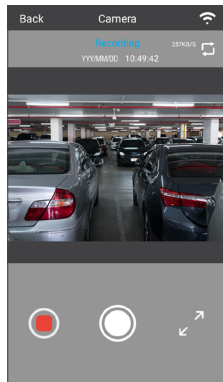
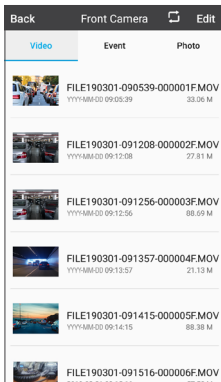
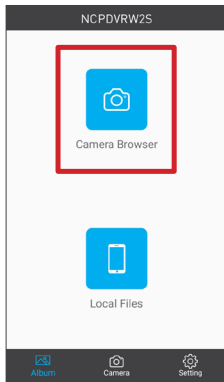

17.2 VIDEO DOWNLOAD

1. Open the NCP-Konnect App.
2. Press the Camera Browser Icon.
3. Press the Edit Icon on the top right of App.
4. Select a Video to download.
5. Press the Save Button and the video will download.

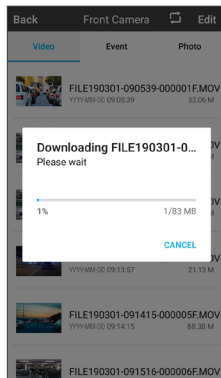
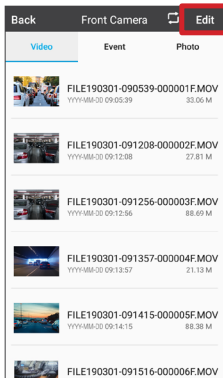
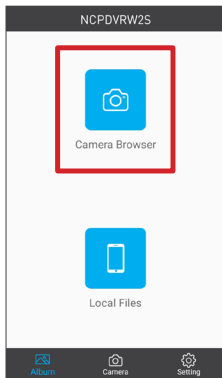

17.3 SHARING A FILE ON SOCIAL MEDIA

1. Open the NCP-Konnect App.
2. Press the Local Files Icon.
3. Press the Share Icon on the bottom.
Note: Files need to be downloaded from the Dash Camera to your smartphone before sharing.
4. Select an App to share / upload the file to.

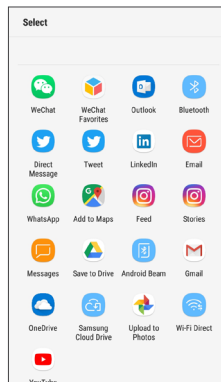
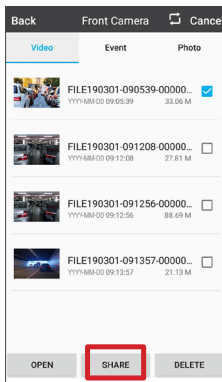
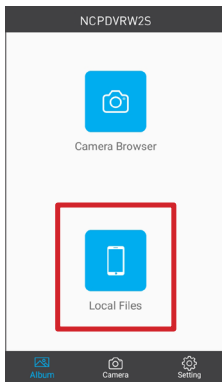

18.0 WARRANTY TERMS & CONDITIONS

Our goods come with guarantees that cannot be excluded under the Australian Consumer Law. You are entitled to a replacement or refund for a major failure and for compensation for any other reasonably foreseeable loss or damage. You are also entitled to have the goods repaired or replaced if the goods fail to be of acceptable quality and the failure does not amount to a major failure.

This warranty is provided in addition to your rights under the Australian Consumer Law. Directed Electronics Australia Pty Ltd (Directed Electronics) warrants that this product is free from defects in material and workmanship for a period of 12 months from the date of purchase or for the period stated on the packaging. This warranty is only valid where you have used the product in accordance with any recommendations or instructions provided by Directed Electronics.

This warranty excludes defects resulting from alterations of the product, accident, misuse, abuse or neglect. In order to claim the warranty, you must return the product to the retailer from which it was purchased or if that retailer is part of a national network, a store within that chain, along with satisfactory proof of purchase. The retailer will then return the goods to Directed Electronics.

Directed Electronics will repair, replace or refurbish the product at its discretion. The retailer will contact you when the product is ready for collection. All costs involved in claiming this warranty, including the cost of the retailer sending the product to Directed Electronics, will be borne by you.

Email: info@nanocamplus.com.au | **Ph:** +61 03 8331 4800

INDEMNITY

You agree to defend, indemnify and hold harmless Nanocam Plus and its subsidiaries and affiliates from and against any and all claims, proceedings, injuries, liabilities, losses, costs and expenses (including reasonable legal fees), including but not limited to, claims alleging negligence, invasion of privacy, copyright infringement and/or trademark infringement against Nanocam Plus and its subsidiaries and affiliates, relating to or arising out of your breach of any provision of these terms, your misuse of Nanocam Plus products or its services, or your unauthorised modification or alteration of products or software.

WARRANTY AND WARRANTY DISCLAIMER

Nanocam Plus has a limited warranty on whereby Nanocam Plus warrants to you and only to you that this Nanocam Plus product will be free from defects in materials and workmanship for one (1) year from the date of your purchase (unless a longer warranty period is required by law). The specifics of this Nanocam Plus limited warranty are covered in this manual. To the extent possible under governing law, other than the above product warranty for the Nanocam Plus product, you understand and agree that the Nanocam Plus products and services are provided on an "as is" and "as available" basis. Nanocam Plus makes no warranty that the Nanocam Plus products and services will meet your requirements or that use of the Nanocam Plus products and services will be uninterrupted, timely, secure or error-free nor does Nanocam Plus make any warranty as to the accuracy or reliability of any information obtained through Nanocam Plus (including third party content), that any defects in Nanocam Plus products and services will be corrected or that Nanocam Plus products or services will be compatible with any other specific hardware or service. Further, Nanocam Plus does not warrant that Nanocam Plus products or services or Nanocam Plus servers will provide you with data and

content are free of viruses or other harmful components. Nanocam Plus also assumes no responsibility for and shall not be liable for any damages caused by viruses that may infect your Nanocam Plus product or software. In the event of any loss, damage or injury, you will not look to Nanocam Plus to compensate you or anyone else. You release and waive for yourself and your insurer all subrogation and other rights to recover against Nanocam Plus arising as a result of the payment of any claim for loss, damage or injury. Nanocam Plus equipment and services do not cause and cannot eliminate occurrences of certain events and Nanocam Plus makes no guarantee or warranty, including any implied warranty of merchantability or fitness for a particular purpose or that Nanocam Plus equipment and services provided will detect or avert such incidents or their consequences. Nanocam Plus does not undertake any risk that you or property, or the person or property of others, may be subject to injury or loss if such an event occurs. The allocation of such risks remains with you, not Nanocam Plus. Other than the above product warranty for Nanocam Plus products, its suppliers disclaim all warranties of any kind, whether express, implied, or statutory, regarding Nanocam Plus products and services, including any implied warranty of title, merchantability, fitness for a particular purpose, or non-infringement of third party rights. Because some jurisdictions do not permit the exclusion of implied warranties, the last sentence of this section may not apply to you. Nanocam Plus hereby further expressly disclaims all liability for claims for service failures that are due to normal product wear, product misuse, abuse, product modification, improper product selection or you noncompliance with all applicable federal, state or local laws.

This warranty and warranty disclaimer give you specific legal rights, and you may have other rights that vary by state, province or country. Other than as permitted by law, Nanocam Plus does not exclude, limit or suspend other rights you have, including those that may arise from the non-conformity of a sales contract. For a full understanding of your rights, you should

consult the laws of your state, province, or country. For our Australian customers: please note that this warranty is in addition to any statutory rights in Australia in relation to your goods which, pursuant to the Australian Consumer Law, cannot be excluded.

LIMITATIONS OF NANOCAM PLUS LIABILITY

Under no circumstances will Nanocam Plus be liable in any way for any content, including, but not limited to, the loss of content, any errors or omissions in any content, or any loss or damage of any kind incurred in connection with use of or exposure to any content posted, emailed, accessed, transmitted, or otherwise made available via Nanocam Plus. Nanocam Plus liability for damages, especially for breach of duty or obligation, delay in performance, non-performance, or malperformance shall be precluded, except when these are due to negligent breaches of any significant contractual duty or obligation on the part of Nanocam Plus. Any liability for negligence is limited to direct losses usually and typically foreseeable in such case. Should the claim for damages be based on wilful or grossly negligent breach of contractual duty or obligation on the part of Nanocam Plus, the preclusion and limitation of liability mentioned in the preceding sentences will not apply. The preceding preclusion and limitation of liability will also not apply to claims for damages arising out of loss of life, bodily injury or health impacts for which Pixbee may be liable, or for non-contractual liability.

Some states and countries do not allow the exclusion or limitation of incidental or consequential damages, so the above limitation or exclusion may not apply to you. Additionally, this provision is not intended to limit Nanocam Plus' liability in the event of Nanocam Plus' wilful or intentional misconduct.

Your Safety. Our Priority



All Images, Information and Content are Copyright © 2022
Directed Electronics Australia Pty Ltd. All Rights Reserved.

DIRECTED

www.directed.com.au

www.directed.co.nz